

# Pack Information

## 1200mm pallet size

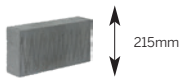

Block Thickness (mm) = T	75	100	140	150	200	215	275	300	355
<b>Celcon Blocks and Celcon Foundation Blocks – 440 x 215mm face size</b> Blocks/m <sup>2</sup> laid 9.88 (10mm joints)									
Coverage per pack (m <sup>2</sup> )	16	12	8	8	6	5	4	4	3
Number of blocks per pack	160	120	80	80	60	50	40	40	30
Pack width (mm) = W	1200	1200	1120	1200	1200	1075	1100	1200	1065
Pack weight – Solar Grade (kg)*	-	660	-	-	-	590	-	-	-
Pack weight – Standard Grade (kg)*	875	875	815	875	875	785	800	875	775
Pack weight – High Strength (kg)*	-	1175	1095	1175	1175	1055	1075	1175	1045

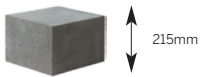

<b>Celcon Foundation Blocks – Blocks/m<sup>2</sup> laid 13.27 (10mm joints)</b>									<b>325 x 215mm</b>
Coverage per pack (m <sup>2</sup> ) – 10mm joint	-	-	-	-	-	-	-	3	-
Number of blocks per pack	-	-	-	-	-	-	-	40	-
Pack width (mm) = W	-	-	-	-	-	-	-	1075	-
Pack weight – Standard Grade (kg)*	-	-	-	-	-	-	-	646	-
Pack weight – High Strength/Super Strength (kg)*	-	-	-	-	-	-	-	742	-

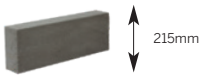

<b>Celcon Plus Blocks – 630 x 215mm face size</b> Blocks/m <sup>2</sup> laid 6.94 (10mm joints) 7.29 (2mm joints)									
Coverage per pack (m <sup>2</sup> ) – 10mm joint	-	8.6	5.8	5.8	4.3	-	-	-	-
Coverage per pack (m <sup>2</sup> ) – 2mm joint	-	8.2	5.5	5.5	4.1	-	-	-	-
Number of blocks per pack	-	60	40	40	30	-	-	-	-
Pack width (mm) = W	-	1200	1120	1200	1200	-	-	-	-
Pack weight – Solar Grade (kg)*	-	470	440	470	470	-	-	-	-
Pack weight – Standard Grade (kg)*	-	620	575	620	620	-	-	-	-
Pack weight – High Strength/Super Strength (kg)*	-	720	671	720	720	-	-	-	-

**Celcon Blocks and Celcon Foundation Blocks** (440mm x 215mm)

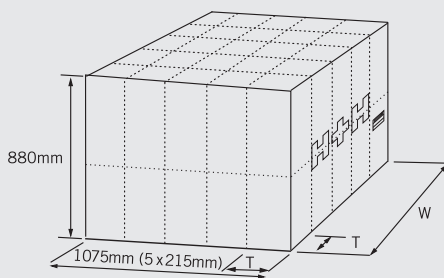

**Celcon Foundation Blocks** (325mm x 215mm)

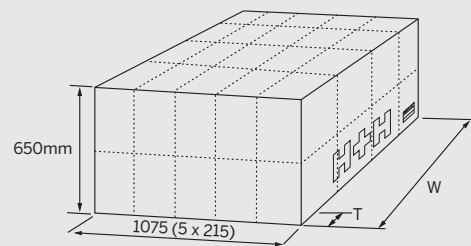

**Celcon Plus Blocks** (630mm x 215mm)

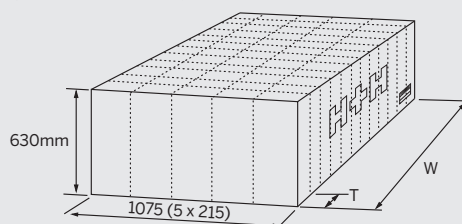

# Pack Information

## 1200mm pallet size

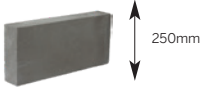

Block Thickness (mm) = T	75	100	140	150	200	215	275	300	355
<b>Jumbo Blok – 630 x 250mm face size Blocks/m<sup>2</sup> laid 6.28 (2mm joints)</b>									
Coverage per pack (m <sup>2</sup> ) – 2mm joint	-	7.6	5.1	-	-	-	-	-	-
Number of blocks per pack	-	48	32	-	-	-	-	-	-
Pack width (mm) = W	-	1200	1120	-	-	-	-	-	-
Pack weight – Solar Grade (kg)*	-	440	410	-	-	-	-	-	-
Pack weight – Standard Grade (kg)*	-	620	535	-	-	-	-	-	-
Pack weight – High Strength/Super Strength (kg)*	-	720	625	-	-	-	-	-	-
<b>Coursing Units – 215 x 65mm face size</b>									
Coverage per pack (m <sup>2</sup> ) – 10mm joint	-	10.1	5.1	5.1	-	-	-	-	-
Coverage per pack (m <sup>2</sup> ) – 2mm joint	-	8.7	4.4	4.4	-	-	-	-	-
Pack height (mm) = H	-	800	560	600	-	-	-	-	-
Number of units per pack	-	600	300	300	-	-	-	-	-
Pack weight – Standard Grade (kg)*	-	645	455	485	-	-	-	-	-
Pack weight – High Strength/Super Strength (kg)*	-	870	610	650	-	-	-	-	-

\*Pack weight excludes pallet

**Celcon Coursing Units**  
(215mm x 65mm x 100mm)

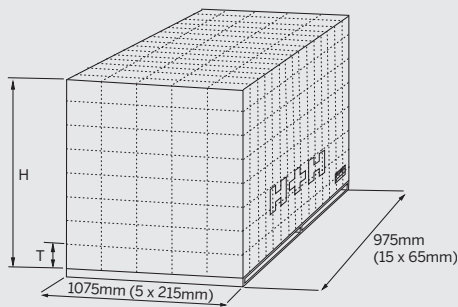

**Jumbo Bloks**  
(630mm x 250mm)

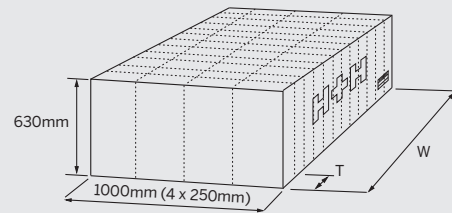

**Celcon Coursing Units**  
(215mm x 65mm)

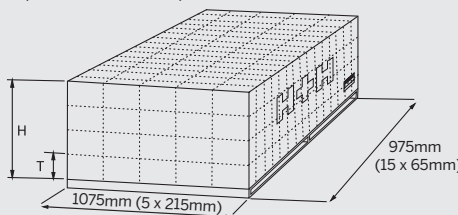

Note: Block thickness at 100mm unless otherwise stated